



描述

三防通路灯外壳由铝合金压铸成型，表面喷涂纯环氧树脂粉末，抗腐蚀性能好。外露紧固件采用不锈钢材料。内装高纯铝镜面反射器，照明范围大、亮度高。三防通路灯从下面进线，适用于橡套电缆布线。根据用户不同的要求可选配不同的光源，配置金属卤化物灯或高压钠灯时，灯体内装有镇流器、触发器和补偿电容。适合亮度要求较高的道路和各种户外场所，能满足石油、化工、医药、军工、食品、电厂等企业的照明之用。

三防通路灯设多角度可调节的安装支架。

- 防护等级高达IP65
- 安装维护方便

Descriptions

The enclosures of weather-proof tunnel light fittings are made of die-cast aluminum alloy, with epoxy resin powder sprayed on their surfaces, so that they have good anti-corrosion performance. The exposed fasteners are made of stainless steel. The built-in high-purity aluminum reflector is within the features, long illuminating range, high brightness. Weather-proof tunnel light fitting's terminal box down entry, is suitable for rubber-coated cable wiring. The weather-proof tunnel light fitting can be selected and matched with different light sources according to the user's different requirements. The ballast, the trigger and compensation capacitor will be mounted in the light body if the metal halide lamp or high pressure sodium lamp is selected as the light source. It is suitable for streets and outdoor locations with high-brightness requirement and can satisfy the related requirements of illumination in petroleum, petrochemical, medical, military, food and power supply industries.

The weather-proof tunnel light fitting is fitted with mounting bracket which can adjust from multi-angle.

- The degree of protection is up to IP65.
- It is convenient to be mounted and maintained.

- 配光曲线 Luminous intensity distribution curve: — C0°/180
— C90°/270

光强单位 luminous intensity unit: cd/1000 Lm

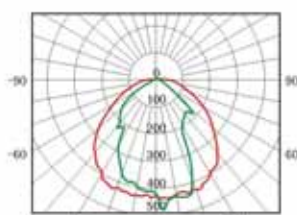

M087B-J70W

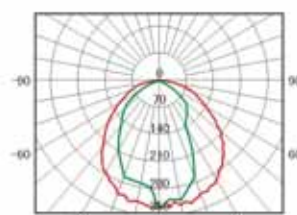

M087B-J150W

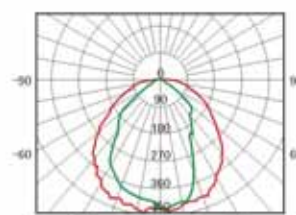

M087B-N100W

主要数据 Main technical data:

防腐标志: WF1
 防护等级: IP65
 额定电压: 220V AC 50Hz
 220V AC, 230V AC, 240V AC 50Hz, 60Hz
 使用环境温度: $-40^{\circ}\text{C} < \text{Ta} < 50^{\circ}\text{C}$
 接线端子: L1, N: $2 \times 2.5\text{mm}^2$, PE 端子 $2 \times 10\text{mm}^2$
 电缆入口: 铜制 $1 \times \text{M}16 \times 1.5$,
 电缆外径: $\Phi 6-8\text{mm}$

Corrosion-proof mark: WF1
 Degree of protection: IP65
 Rated voltage: 220V AC 50Hz
 220V AC, 230V AC, 240V AC 50Hz, 60Hz
 Ambient temperature: $-40^{\circ}\text{C} < \text{Ta} < 50^{\circ}\text{C}$
 Terminal: L1, N: $2 \times 2.5\text{mm}^2$,
 PE terminal: $2 \times 10\text{mm}^2$
 Cable entry: Copper $1 \times \text{M}16 \times 1.5$,
 Outside diameter: $\Phi 6-8\text{mm}$

订购规格 Order specifications:

图样 Illustration	光源代号 Code of light source	灯座代号 Lampholder code	功率 Power	重量 Weight	订购号 Order No.
 M087B	金属卤化物灯-J Metal halide lamp-J	E27	70W	6kg	M087B-J70W25
		E27	100W	6.8kg	M087B-J100W25
		E27	150W	6.8kg	M087B-J150W25
	高压钠灯-N High pressure sodium vapor lamp-N	E27	70W	6kg	M087B-N70W25
		E27	100W	6.27kg	M087B-N100W25

额定电压 Rated voltage ←
 2 — 220V AC 4 — 240V AC
 3 — 230V AC
 额定频率 Rated frequency ←
 5 — 50Hz
 6 — 60Hz

光源备件 Spare parts of light source:

图样 Illustration	功率 Power	灯座 Lampholder	光通量 Luminous flux	单位 Unit	订购号 Order No.
金属卤化物灯泡-J Metal halide lamp bulb-J 	70W	E27	5000lm	只 Piece	HQI - E 70/N
	100W	E27	8700lm	只 Piece	HQI - E 100/N
	150W	E27	12500lm	只 Piece	HQI - E 150/N
高压钠灯灯泡-N High pressure sodium vapor lamp bulb-N 	70W	E27	5900lm	只 Piece	NAV - T 70
	100W	E27	10000lm	只 Piece	NAV - T 100

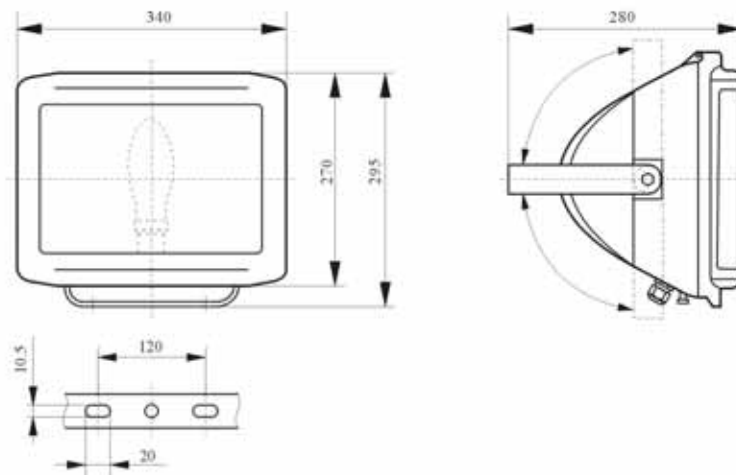
外形及安装尺寸 Outline and installation dimensions:



描述

三防应急通路灯外壳由铝合金压铸成型，表面喷涂纯环氧树脂粉末，抗腐蚀性能好。外露紧固件采用不锈钢材料。内装高纯铝镜面反射器，照明范围大、亮度高。三防应急通路灯从下面进线，适用于橡胶套电缆布线。适合亮度要求较高的道路和各种户外场所，能满足石油、化工、医药、军工、食品、电厂等企业的照明之用。

三防应急通路灯配有金属卤化物灯泡和电源箱，箱内装有镇流器、逆变器、锂电池。

三防应急通路灯设多角度可调节的安装支架。

- 防护等级高达IP65
- 安装维护方便

Descriptions

The enclosures of weather-proof emergency tunnel light fittings are made of die-cast aluminum alloy, with epoxy resin powder sprayed on their surfaces, so that they have good anti-corrosion performance. The exposed fasteners are made of stainless steel. The built-in high-purity aluminum reflector is within the features, long illuminating range, high brightness. Weather-proof emergency tunnel light fitting's terminal box down entry, is suitable for rubber-coated cable wiring. It can satisfy the related requirements of illumination in petroleum, petrochemical, medical, military, food and power supply industries.

The weather-proof emergency tunnel light fittings is fitted with power box in which the electronic ballast, inverter, lithium battery are mounted inside.

The weather-proof emergency tunnel light fittings is fitted with mounting brackets which can be adjusted from multi-angle.

- The degree of protection is up to IP65.
- It is convenient to be mounted and maintained.

● 应急灯具安装线路图

Mounting circuit diagram for emergency light fittings:

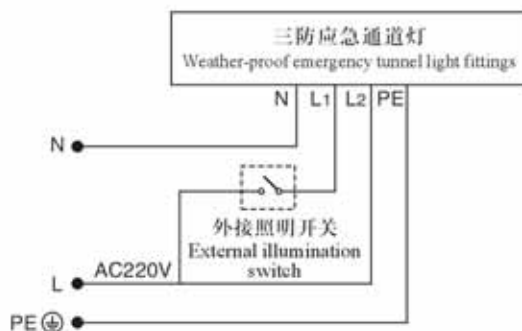

● 配光曲线 Luminous intensity distribution curve:

光强单位 luminous intensity unit: cd/1000 Lm — C0°180°
C90°270°

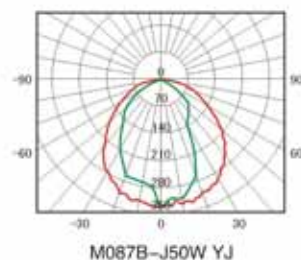

● 主要数据 Main technical data:

防腐标志: WF1
 防护等级: IP65
 额定电压: 160 ~ 260V AC 50/60Hz
 充电时间: 24h
 应急启动时间: 0.1 (S)
 应急照明时间: >60 (min)
 使用环境温度: -40℃ < Ta < 50℃
 接线端子: L1, N: 2-2.5mm², PE 端子 2 × 10mm²
 电缆入口: 铜制 1 × M16 × 1.5,
 电缆外径: Φ6-8mm
 电源线电缆入口: 2 × M20 × 1.5, 电缆外径: Φ5.5-13mm

Corrosion-proof mark: WF1
 Degree of protection: IP65
 Rated voltage: 160 ~ 260V AC 50/60Hz
 Recharging time: 24 (h)
 Emergency starting time: 0.1(S)
 Emergency illuminating time: >60(min)
 Ambient temperature: -40℃ < Ta < 50℃
 Terminal: L1, N: 2-2.5mm²,
 PE terminal: 2 × 10mm²
 Cable entry: Coppery 1 × M16 × 1.5,
 Outside diameter: Φ6-8mm
 Cable entry of the power line: 2 × M20 × 1.5
 Outside diameter: Φ5.5-13mm

● 订购规格 Order specifications:

图样 Illustration	光源代号 Code of light source	灯座代号 Lampholder code	功率 Power	重量 Weight	订购号 Order No.
	金属卤化物灯-J Metal halide lamp-J	E27	50W	5.46kg	M087B-J50W YJ
M087B-YJ					

● 光源备件 Spare parts of light source:

图样 Illustration	功率 Power	灯座 Lampholder	光通量 Luminous flux	单位 Unit	订购号 Order No.
金属卤化物灯泡-J Metal halide lamp bulb-J 	50W	E27	3400lm	只 Piece	JL Z50KN

● 外形及安装尺寸 Outline and installation dimensions:

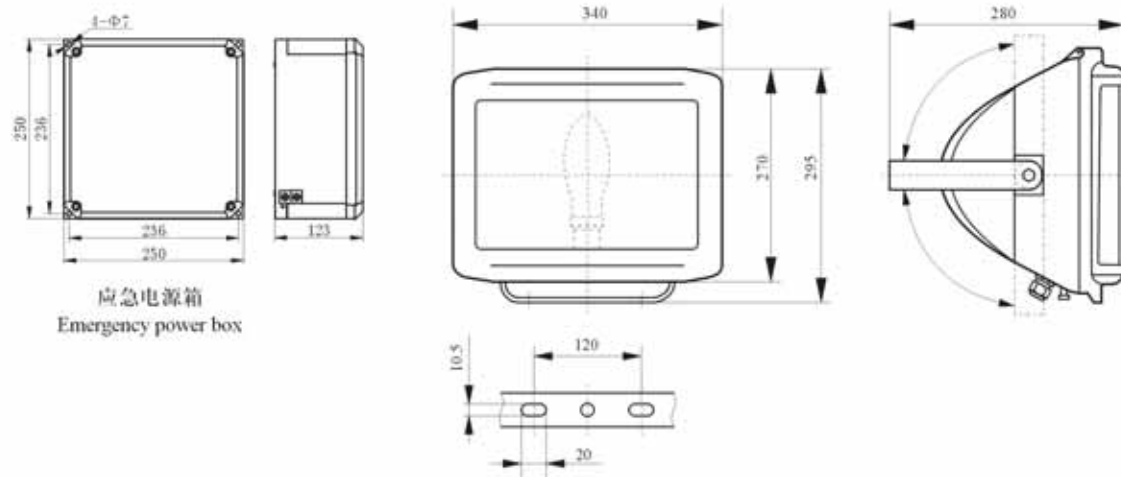



描述

三防通路灯外壳由铝合金压铸成型，表面喷涂纯环氧树脂粉末，抗腐蚀性能好。外露紧固件采用不锈钢材料。内装高纯铝镜面反射器，照明范围大、亮度高。三防通路灯从下面进线，适用于橡胶套电缆布线。根据用户不同的要求可选配不同的光源，配置金属卤化物灯或高压钠灯时，灯体内装有镇流器、触发器和补偿电容。适合亮度要求较高的道路和各种户外场所，能满足石油、化工、医药、军工、食品、电厂等企业的照明之用。

三防通路灯设多角度可调节的安装支架。

- 防护等级高达IP65
- 安装维护方便

Descriptions

The enclosures of weather-proof tunnel light fittings are made of die-cast aluminum alloy, with epoxy resin powder sprayed on their surfaces, so that they have good anti-corrosion performance. The exposed fasteners are made of stainless steel. The built-in high-purity aluminum reflector is within the features, long illuminating range, high brightness. Weather-proof tunnel light fitting's terminal box down entry, is suitable for rubber-coated cable wiring. The weather-proof tunnel light fitting can be selected and matched with different light sources according to the user's different requirements. The ballast, the trigger and compensation capacitor will be mounted in the light body if the metal halide lamp or high pressure sodium lamp is selected as the light source. It is suitable for streets and outdoor locations with high-brightness requirement and can satisfy the related requirements of illumination in petroleum, petrochemical, medical, military, food and power supply industries.

The weather-proof tunnel light fitting is fitted with mounting bracket which can adjust from multi-angle.

- The degree of protection is up to IP65.
- It is convenient to be mounted and maintained.

- 配光曲线 Luminous intensity distribution curve: — 00/180
光强单位 luminous intensity unit: cd/1000 Lm — 090/270

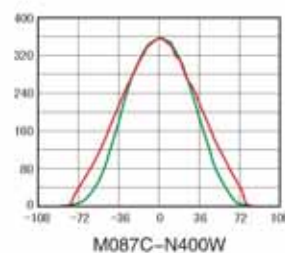
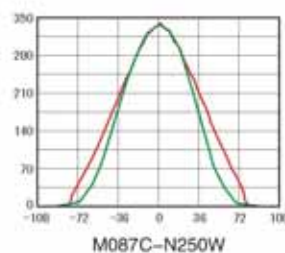
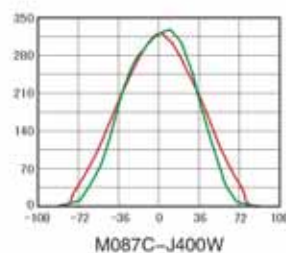
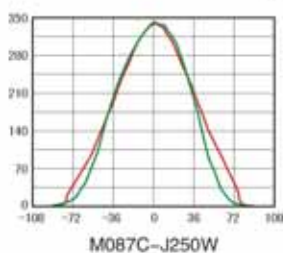

● 主要数据 Main technical data:

防腐标志: WF1
 防护等级: IP65
 额定电压: 220V AC 50Hz
 220V AC, 230V AC, 240V AC 50Hz, 60Hz
 使用环境温度: $-40^{\circ}\text{C} < \text{Ta} < 50^{\circ}\text{C}$
 接线端子: L1, N: $2 \times 2.5\text{mm}^2$, PE 端子 $2 \times 10\text{mm}^2$
 电缆入口: 铜制 $2 \times \text{M}20 \times 1.5$,
 电缆外径: $\Phi 10\text{-}14\text{mm}$

Corrosion-proof mark: WF1
 Degree of protection: IP65
 Rated voltage: 220V AC 50Hz
 220V AC, 230V AC, 240V AC 50Hz, 60Hz
 Ambient temperature use: $-40^{\circ}\text{C} < \text{Ta} < 50^{\circ}\text{C}$
 Terminal: L1, N: $2 \times 2.5\text{mm}^2$,
 PE terminal: $2 \times 10\text{mm}^2$
 Cable entry: Copper $2 \times \text{M}20 \times 1.5$,
 Outside diameter: $\Phi 10\text{-}14\text{mm}$

● 订购规格 Order specifications:

图样 Illustration	光源代号 Code of light source	灯座代号 Lampholder code	功率 Power	重量 Weight	订购号 Order No.
 M087C	金属卤化物灯-J Metal halide lamp-J	E40	250W	14.3kg	M087C-J250W25
		E40	400W	16kg	M087C-J400W25
	高压钠灯-N High pressure sodium vapor lamp-N	E40	250W	14.3kg	M087C-N250W25
		E40	400W	16kg	M087C-N400W25

额定电压 Rated voltage ←
 2 — 220V AC 4 — 240V AC
 3 — 230V AC
 额定频率 Rated frequency ←
 5 — 50Hz
 6 — 60Hz

● 光源备件 Spare parts of light source:

图样 Illustration	功率 Power	灯座 Lampholder	光通量 Luminous flux	单位 Unit	订购号 Order No.
 金属卤化物灯泡-J Metal halide lamp bulb-J	250W	E40	20500lm	只 Set	HQI-T250/D
	400W	E40	32000lm	只 Set	HQI-BT400/D
 高压钠灯灯泡-N High pressure sodium vapor lamp bulb-N	250W	E40	27000lm	只 Set	NAV - T 250
	400W	E40	48000lm	只 Set	NAV - T 400

● 外形及安装尺寸 Outline and installation dimensions:

