



描述:

全塑三防(应急)荧光灯壳体 and 透明罩采用高抗冲击、抗紫外线的聚碳酸酯注塑成型,其稳定性及机械强度高,对工厂中多种化学物质具有良好的防护能力;本灯具采用的材料均能有效地防止有机化合物的腐蚀;密封系统采用双边铰链式锁扣设计,具有防护等级高、开合方便、维修简单等优点;本灯具广泛用于在220V AC、50Hz 线路中作为石油、化工、医药、军工、食品等工厂企业的照明之用。

全塑三防 LED 灯内装有“CZ”LED灯管、灯座、接线端子等。

全塑三防荧光灯内装有专用电子镇流器、灯座、接线端子等。

全塑三防(应急)荧光灯内装有专用电子镇流器、逆变器、耐高温电池等。本灯具在正常使用时自动充电,事故断电或停电时自动点亮灯管。

安装形式分为:吸顶式、吊链式、吊杆式、壁式和夹管式。

- 安装形式分为:平台护栏式、平台法兰式。
- 永不变形的结构设计,防护等级高达IP66。
- 双边铰链式锁扣设计,开合方便,维修简单
- 外露紧固件设计为不锈钢

● 应急灯具安装线路图 Mounting circuit diagram for emergency light fittings:



Descriptions:

The enclosures and the transparent shields of full plastic weather-proof (emergency) fluorescent light fittings are made of polycarbonate, which is highly stable, has strong mechanical strength and good resistance against many kinds of chemical matters in factories. The material of the light fitting can also prevent organic corrosion effectively. The double sides articulated claps type is designed in the sealing system, which has the characters of high degree of protection, opening and closing conveniently and maintained conveniently. The full plastic weather-proof (emergency) fluorescent light fitting is widely used for illuminating of petroleum, petrochemical, medical, military, food and power supply industries in the circuit of 220V AC、50Hz.

“CZ” LED lamp tube, light fitting lampholder, terminal so on are built-in full plastic weather-proof LED light fittings. The full plastic weather-proof fluorescent light fitting is fitted with special electronic ballast, lampholder, and terminals and so on.

The full plastic weather-proof (emergency) fluorescent light fitting is mounted with special electronic ballast, inverter, and high temperature resistance battery and so on. It can automatically be recharged while normal working, so that the lamp tube will be turned on when the power is off because of accident or power failure.

The mounting ways are ceiling type, chain type, pendant type, wall type and clap type.

The mounting ways are platform fence and platform flange type.

- The structural design will never be distorted and the degree of protection is up to IP66.
- The double sides articulated claps type is designed and it is convenient to be opened and closed and be maintained.
- The exposed fasteners are made of stainless steel.

● 主要数据 Main technical data:

防腐标志: WF2
 防护等级: IP66
 额定电压: 100-240V AC 50/60Hz
 灯座代号: G13 双脚灯管
 接线端子: L, N, PE, 每个端子2 × 1.5-10mm²
 外壳材料: 聚碳酸酯

Corrosion-proof mark: WF2
 Degree of protection: IP66
 Rated voltage: 100-240V AC 50/60Hz
 Lampholder code: G13: Two-pin lamp tube
 Terminals: L, N, PE, Each terminal 2 × 1.5-10mm²
 The material of enclosure: Polycarbonate

● 订购规格 Order specifications:

图样 Illustration	功率 Power	重量 Weight	订购号 Order No.
 M0875	LED 2 × 12W	3.4kg	M0875 / LED 2 × 12WT-B+□
	LED 2 × 23W	5kg	M0876 / LED 2 × 23WT-B+□
 M0876	“CZ” LED灯管 ← “CZ” LED tubes 电缆引入装置编码 Code of cable gland ← 安装附件订购号（不配不注）见 215-216页 ← Order No. of mounting accessories (No matching not noted), see page 215-216		

● 电缆引入装置编码 Code of cable gland

编码 Code	规格 Specifications	电缆直径 Cable diameter
B	塑制 1 个 M25 × 1.5 电缆密封套, 塑制 2 个 M25 × 1.5 空塞堵头 One moulded plastic M25 × 1.5 cable gland, two moulded plastic M25 × 1.5 stopping plugs	Φ8-17mm
C	铜制 1 个 CZ0221/M25 × 1.5 金属电缆密封套, 塑制 2 个 M25 × 1.5 空塞堵头 One brass CZ0221/M25 × 1.5 metal cable gland, two moulded plastic M25 × 1.5 stopping plugs	Φ8-17mm
D	塑制 2 个 M25 × 1.5 电缆密封套, 塑制 1 个 M25 × 1.5 空塞堵头 Two moulded plastic M25 × 1.5 cable glands, one moulded plastic M25 × 1.5 stopping plug	Φ8-17mm
E	铜制 2 个 CZ0221/M25 × 1.5 金属电缆密封套, 塑制 1 个 M25 × 1.5 空塞堵头 Two brass CZ0221/M25 × 1.5 metal cable glands, one moulded plastic M25 × 1.5 stopping plug	Φ8-17mm
F	铜制 1 个 CZ0227/M25 × 1.5-G ^{3/4} 增安型金属电缆密封套, 塑制 2 个 M25 × 1.5 空塞堵头 One brass CZ0227/M25 × 1.5-G ^{3/4} increased safety metal cable gland, two moulded plastic M25 × 1.5 stopping plugs	Φ11-15mm
G	铜制 2 个 CZ0227/M25 × 1.5-G ^{3/4} 增安型金属电缆密封套, 塑制 1 个 M25 × 1.5 空塞堵头 Two brass CZ0227/M25 × 1.5-G ^{3/4} increased safety metal cable glands, one moulded plastic M25 × 1.5 stopping plug	Φ11-15mm
H	铜制 1 个 CZ0226/M25 × 1.5(G02) 增安型金属电缆密封套(填料函), 塑制 2 个 M25 × 1.5 空塞堵头 One brass CZ0226/M25 × 1.5(G02) increased safety metal cable gland (stopping boxes), two moulded plastic M25 × 1.5 stopping plugs	Φ11.5-16mm
I	铜制 2 个 CZ0226/M25 × 1.5(G02) 增安型金属电缆密封套(填料函), 塑制 1 个 M25 × 1.5 空塞堵头 Two brass CZ0226/M25 × 1.5(G02) increased safety metal cable glands (stopping boxes), one moulded plastic M25 × 1.5 stopping plug	Φ11.5-16mm

● 配光曲线 Luminous intensity distribution curve: — C0/180

— C90/270

光强单位 luminous intensity unit: cd/1000 lm

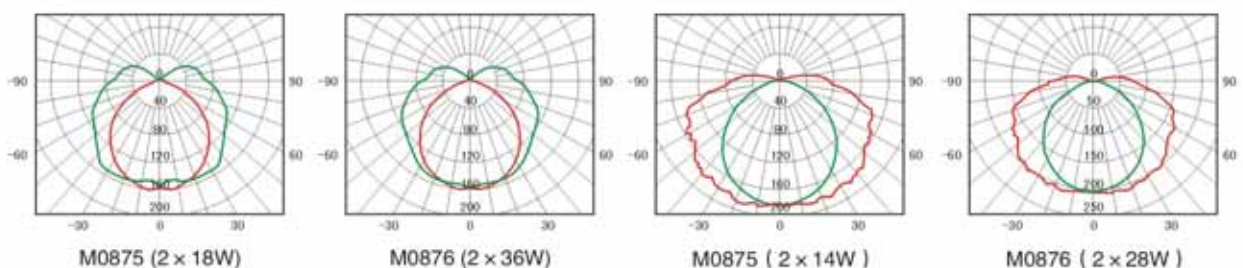

主要数据 Main technical data:

防腐标志: WF2
 防护等级: IP66
 额定电压: 220-240V AC 50/60Hz
 功率因数: $\lambda > 0.95$
 能效指数 EEI=A2
 镇流器: 电子式
 接线端子: L、N、PE, 每个端子 2 × 1.5-10mm²
 电缆入口: 塑制 1 × M25 × 1.5, 电缆外径: $\Phi 8-17\text{mm}$
 塑制 2 × M25 × 1.5 空塞堵头
 注: 内装镇流器可按用户要求选用指定品牌

Corrosion-proof mark: WF2
 Degree of protection: IP66
 Rated voltage: 220-240V AC 50/60Hz
 Power factor: $\lambda > 0.95$
 Energy efficiency index EEI=A2
 Ballast: Electronic type
 Terminals: L、N、PE, each terminal 2 × 1.5-10mm²
 Cable entry: Moulded plastic 1 × M25 × 1.5 cable gland,
 Outside diameter of cable: $\Phi 8-17\text{mm}$
 Moulded plastic 2 × M25 × 1.5 stopping plugs
 Note: The specified brand of the built-in ballast can be used as per user's request.

订购规格 Order specifications:

图样 Illustration	灯座代号 Lampholder code	镇流器 Ballast	功率 Power	电流 Current	重量 Weight	订购号 Order No.
	G5 双脚灯座 G5 Two-pin lampholder	电子式 Electronic type	2 × 14W	max 0.16A	3.2kg	M0875 / 2 × 14WE -B+□
			2 × 28W	max 0.33A	4.83kg	M0876 / 2 × 28WE -B+□
M0875	G13 双脚灯座 G13 Two-pin lampholder	电子式 Electronic type	2 × 18W	max 0.2A	3.32kg	M0875 / 2 × 18WE -B+□
			2 × 36W	max 0.39A	4.9kg	M0876 / 2 × 36WE -B+□



M0876

电缆引入装置编码 Code of cable gland ←

 安装附件订购号 (不配不注) 见 215-216 页
 Order No. of mounting accessories (No matching not noted), see page 215-216

电缆引入装置编码 Code of cable gland

编码 Code	规格 Specifications	电缆直径 Cable diameter
B	塑制 1 个 M25 × 1.5 电缆密封套, 塑制 2 个 M25 × 1.5 空塞堵头 One moulded plastic M25 × 1.5 cable gland, two moulded plastic M25 × 1.5 stopping plugs	$\Phi 8-17\text{mm}$
C	铜制 1 个 CZ0221/M25 × 1.5 金属电缆密封套, 塑制 2 个 M25 × 1.5 空塞堵头 One brass CZ0221/M25 × 1.5 metal cable gland, two moulded plastic M25 × 1.5 stopping plugs	$\Phi 8-17\text{mm}$
D	塑制 2 个 M25 × 1.5 电缆密封套, 塑制 1 个 M25 × 1.5 空塞堵头 Two moulded plastic M25 × 1.5 cable glands, one moulded plastic M25 × 1.5 stopping plug	$\Phi 8-17\text{mm}$
E	铜制 2 个 CZ0221/M25 × 1.5 金属电缆密封套, 塑制 1 个 M25 × 1.5 空塞堵头 Two brass CZ0221/M25 × 1.5 metal cable glands, one moulded plastic M25 × 1.5 stopping plug	$\Phi 8-17\text{mm}$
F	铜制 1 个 CZ0227/M25 × 1.5-G ^{3/4} 增安型金属电缆密封套, 塑制 2 个 M25 × 1.5 空塞堵头 One brass CZ0227/M25 × 1.5-G ^{3/4} increasd safety metal cable gland, two moulded plastic M25 × 1.5 stopping plugs	$\Phi 11-15\text{mm}$
G	铜制 2 个 CZ0227/M25 × 1.5-G ^{3/4} 增安型金属电缆密封套, 塑制 1 个 M25 × 1.5 空塞堵头 Two brass CZ0227/M25 × 1.5-G ^{3/4} increasd safety metal cable glands, one moulded plastic M25 × 1.5 stopping plug	$\Phi 11-15\text{mm}$
H	铜制 1 个 CZ0226/M25 × 1.5(G02) 增安型金属电缆密封套(填料函), 塑制 2 个 M25 × 1.5 空塞堵头 One brass CZ0226/M25 × 1.5(G02) increasd safety metal cable gland (stopping boxes), two moulded plastic M25 × 1.5 stopping plugs	$\Phi 11.5-16\text{mm}$
I	铜制 2 个 CZ0226/M25 × 1.5(G02) 增安型金属电缆密封套(填料函), 塑制 1 个 M25 × 1.5 空塞堵头 Two brass CZ0226/M25 × 1.5(G02) increasd safety metal cable glands (stopping boxes), one moulded plastic M25 × 1.5 stopping plug	$\Phi 11.5-16\text{mm}$

● 主要数据 Main technical data:

防腐标志: WF2
 防护等级: IP66
 额定电压: 220-240V AC 50/60Hz
 功率因数: $\lambda > 0.95$
 能效指数 EEI=A2
 镇流器: 电子式
 充电时间: 24 h
 应急启动时间: 0.1 (S)
 应急照明时间: > 120 (min)
 接线端子: L1、L2、N、PE, 每个端子 2 × 1.5-10mm²
 电缆入口: 塑制 1 × M25 × 1.5, 电缆外径: $\Phi 8-17\text{mm}$
 塑制 2 × M25 × 1.5 空塞堵头
 注: 内装镇流器可按用户要求选用指定品牌

Corrosion-proof mark: WF2
 Degree of protection: IP66
 Rated voltage: 220-240V AC 50/60Hz
 Power factor: $\lambda > 0.95$
 Energy efficiency index EEI=A2
 Ballast: Electronic type
 Recharging time: 24 h
 Emergency starting time: 0.1 (S)
 Emergency illuminating time: > 120 (min)
 Terminals: L1、L2、N、PE, each terminal 2 × 1.5-10mm²
 Cable entry: Moulded plastic 1 × M25 × 1.5 cable gland,
 Outside diameter of cable: $\Phi 8-17\text{mm}$
 Moulded plastic 2 × M25 × 1.5 Stopping plugs
 Note: The specified brand of the built-in ballast can be used as per user's request.

● 订购规格 Order specifications:

图样 Illustration	灯座代号 Lampholder code	镇流器 Ballast	正常照明 Normal illumination	应急照明 Emergency illumination	重量 Weight	订购号 Order No.
 M0875	G5 双脚灯座 G5 Two-pin lampholder	电子式 Electronic type	2 × 14W	1 × 14W	4.9kg	M0875/2 × 14WE YJ -B+□
			2 × 28W	1 × 28W	6.65kg	M0876/2 × 28WE YJ -B+□
 M0876	G13 双脚灯座 G13 Two-pin lampholder	电子式 Electronic type	2 × 18W	1 × 18W	5kg	M0875/2 × 18WE YJ -B+□
			2 × 36W	1 × 36W	6.72kg	M0876/2 × 36WE YJ -B+□

电缆引入装置编码 Code of cable gland ←
 安装附件订购号 (不配不注) 见 215-216 页
 Order No. of mounting accessories (No matching not noted), see page 215-216

● 电缆引入装置编码 Code of cable gland

编码 Code	规格 Specifications	电缆直径 Cable diameter
B	塑制 1 个 M25 × 1.5 电缆密封套, 塑制 2 个 M25 × 1.5 空塞堵头 One moulded plastic M25 × 1.5 cable gland, two moulded plastic M25 × 1.5 stopping plugs	$\Phi 8-17\text{mm}$
C	铜制 1 个 CZ0221/M25 × 1.5 金属电缆密封套, 塑制 2 个 M25 × 1.5 空塞堵头 One brass CZ0221/M25 × 1.5 metal cable gland, two moulded plastic M25 × 1.5 stopping plugs	$\Phi 8-17\text{mm}$
D	塑制 2 个 M25 × 1.5 电缆密封套, 塑制 1 个 M25 × 1.5 空塞堵头 Two moulded plastic M25 × 1.5 cable glands, one moulded plastic M25 × 1.5 stopping plug	$\Phi 8-17\text{mm}$
E	铜制 2 个 CZ0221/M25 × 1.5 金属电缆密封套, 塑制 1 个 M25 × 1.5 空塞堵头 Two brass CZ0221/M25 × 1.5 metal cable glands, one moulded plastic M25 × 1.5 stopping plug	$\Phi 8-17\text{mm}$
F	铜制 1 个 CZ0227/M25 × 1.5-G ^{3/4} 增安型金属电缆密封套, 塑制 2 个 M25 × 1.5 空塞堵头 One brass CZ0227/M25 × 1.5-G ^{3/4} increasd safety metal cable gland, two moulded plastic M25 × 1.5 stopping plugs	$\Phi 11-15\text{mm}$
G	铜制 2 个 CZ0227/M25 × 1.5-G ^{3/4} 增安型金属电缆密封套, 塑制 1 个 M25 × 1.5 空塞堵头 Two brass CZ0227/M25 × 1.5-G ^{3/4} increasd safety metal cable glands, one moulded plastic M25 × 1.5 stopping plugs	$\Phi 11-15\text{mm}$
H	铜制 1 个 CZ0226/M25 × 1.5(G02) 增安型金属电缆密封套(填料函), 塑制 2 个 M25 × 1.5 空塞堵头 One brass CZ0226/M25 × 1.5(G02) increasd safety metal cable gland (stopping boxes), two moulded plastic M25 × 1.5 stopping plugs	$\Phi 11.5-16\text{mm}$
I	铜制 2 个 CZ0226/M25 × 1.5(G02) 增安型金属电缆密封套(填料函), 塑制 1 个 M25 × 1.5 空塞堵头 Two brass CZ0226/M25 × 1.5(G02) increasd safety metal cable glands (stopping boxes), one moulded plastic M25 × 1.5 stopping plug	$\Phi 11.5-16\text{mm}$

● 安装附件 Accessories of mounting:

图样 Illustration	描述 Descriptions	单位 Unit	订购号 Order No.
吊杆式附件 Accessories for pendant type 		套Set	D622
吊链式附件 Accessories for chain type 		套Set	D623
夹管附件M8螺钉安装 Accessories for clamp type M8 bolt mounting 		G1 1/4" Φ42mm 钢制 Steel	套Set J200
		G1 1/4" Φ42mm 不锈钢 Stainless steel	套Set J200/304
		G1 1/2" Φ48mm 钢制 Steel	套Set J300
		G1 1/2" Φ48mm 不锈钢 Stainless steel	套Set J300/304
		G2" Φ60mm 钢制 Steel	套Set J400
		G2" Φ60mm 不锈钢 Stainless steel	套Set J400/304
吸顶式支架 Support for ceiling type 		钢制 Steel	套Set D621
		不锈钢 Stainless steel	套Set D621/304
可调安装支架 Adjustable mounting bracket 		套Set	D8738
井架安装支架 Mounting bracket of oil derrick 		套Set	D8730/1
吸顶式支架 Ceiling bracket 	材质: 304不锈钢 Material: 304 stainless steel	套Set	D8727
壁式灯杆 Lamp pole of wall type 	用于LED12W, 14W, 18W荧光灯 Used for 12W, 14W, 18W fluorescent light fittings	套Set	D8709/1A
	用于LED23W, 28W, 36W荧光灯 Used for 23W, 28W, 36W fluorescent light fittings	套Set	D8709/2A
护栏式灯杆 Lamp pole of fence type 	用于LED12W, 14W, 18W荧光灯 Used for 12W, 14W, 18W fluorescent light fittings	套Set	D8710/1A
	用于LED23W, 28W, 36W荧光灯 Used for 23W, 28W, 36W fluorescent light fittings	套Set	D8710/2A
法兰式灯杆 Lamp pole of flange type 	用于LED12W, 14W, 18W荧光灯 Used for 12W, 14W, 18W fluorescent light fittings	套Set	D8711/1A
	用于LED23W, 28W, 36W荧光灯 Used for 23W, 28W, 36W fluorescent light fittings	套Set	D8711/2A
接地螺母 Earthing nut 	金属接地螺母 2-M25 × 1.5 Metal earthing nut 2-M25 × 1.5	套Set	D8714/2-M25

• 备件 Spare parts:

图样 Illustration	描述 Descriptions	单位 Unit	订购号 Order No.
“CZ” LED灯管 “CZ” LED tubes 	T8 LED12W灯管, G13灯座 电压AC100-240V, 50-60Hz, 光通量825Lm 显色指数85, 色温5500-6500K, 寿命40000小时 T8 LED12W Tube; G13 Cap base Voltage: AC100-240V, 50-60Hz; Luminous flux 825Lm; Color rendering index 85; Color temperature 5500-6500K; Lifetime 40000hours	只 Piece	TLED T8 12W CW G13
	T8 LED23W灯管, G13灯座 电压AC100-240V, 50-60Hz, 光通量1650Lm 显色指数85, 色温5500-6500K, 寿命40000小时 T8 LED23W Tube; G13 Cap base Voltage: AC100-240V, 50-60Hz; Luminous flux 1650Lm; Color rendering index 85; Color temperature 5500-6500K; Lifetime 40000hours	只 Piece	TLED T8 23W CW G13
专用灯座 Special lampholder 	G5 灯座, 用于 T5 节能型荧光灯管 G5 lampholder, used for T5 fluorescent lamp tube of energy saving type	只 Piece	G5-F288(E)
	G13 灯座, 用于 T8 节能型荧光灯管 G13 lampholder, used for T8 fluorescent lamp tube of energy saving type	只 Piece	G13-F266(F)
电子式镇流器模块 Electronic ballast module 	功率: 2 × 14W, 用于 T5 节能型荧光灯 Power: 2 × 14W, used for T5 energy saving type fluorescent light fitting	只 Piece	CDZ 214 LY10A
	功率: 2 × 28W, 用于 T5 节能型荧光灯 Power: 2 × 28W, used for T5 energy saving type fluorescent light fitting	只 Piece	CDZ 228 LY10A
	功率: 2 × 18W, 用于 T8 节能型荧光灯 Power: 2 × 18W, used for T8 energy saving type fluorescent light fitting	只 Piece	CDZ 218 LY10
	功率: 2 × 36W, 用于 T8 节能型荧光灯 Power: 2 × 36W, used for T8 energy saving type fluorescent light fitting	只 Piece	CDZ 236 LY10
专用逆变器模块 Special inverter module 	应急功率: 1 × 14W, 用于 T5 型荧光灯 Emergency power: 1 × 14W, used for T5 type fluorescent light fitting	只 Piece	CDZ-EME14
	应急功率: 1 × 28W, 用于 T5 型荧光灯 Emergency power: 1 × 28W, used for T5 type fluorescent light fitting	只 Piece	CDZ-EME28
	应急功率: 1 × 18W, 用于 T8 型荧光灯 Emergency power: 1 × 18W, used for T8 type fluorescent light fitting	只 Piece	CDZ-EME18
	应急功率: 1 × 36W, 用于 T8 型荧光灯 Emergency power: 1 × 36W, used for T8 type fluorescent light fitting	只 Piece	CDZ-EME36
电池模块 Battery module 	4.5Ah/6V	套 Set	CZ0819/4.5Ah 6V
	4.5Ah/7.2V	套 Set	CZ0819/4.5Ah 7.2V

• 安装形式和外形尺寸 Mounting ways and outline dimensions:

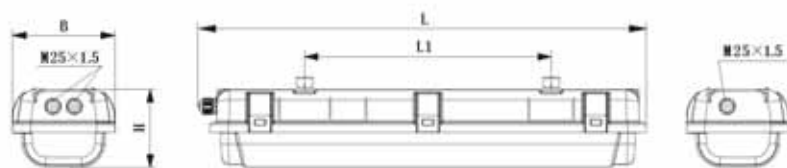

全塑三防荧光灯
Full plastic weather-proof fluorescent light fittings

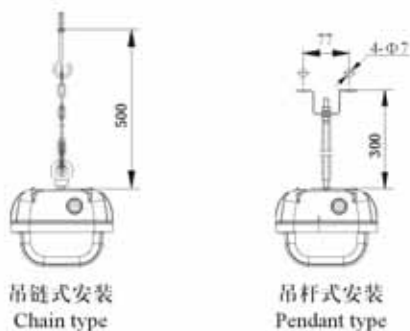

吊链式安装
Chain type

吊杆式安装
Pendant type

型号 Type	M0875 LED 2 × 12W 2 × 14W(18W)	M0876 LED 2 × 23W 2 × 28W(36W)
L	730	1330
L1	400	800
L2	470	870
L3	800	1300
B	168	168
H	128	128
H1	2510	2510
H2	2500	2500
H3	1050	1050

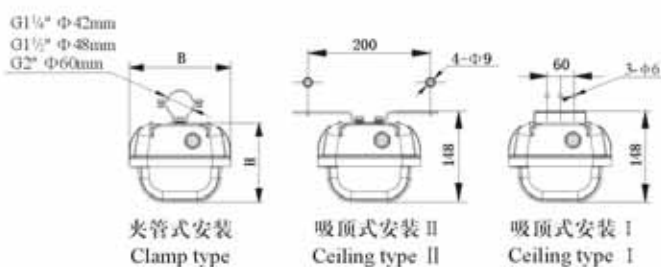

夹管式安装
Clamp type

吸顶式安装 II
Ceiling type II

吸顶式安装 I
Ceiling type I

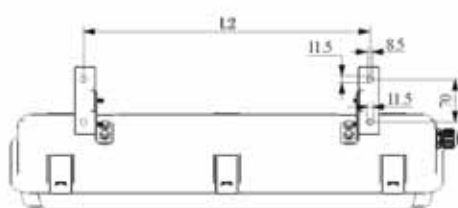
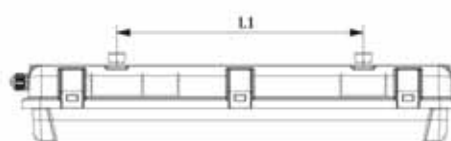

可调支架安装
Adjustable mounting bracket

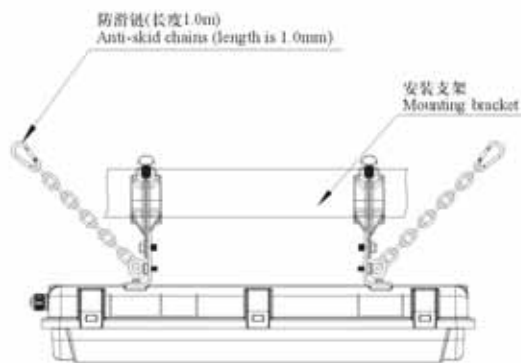
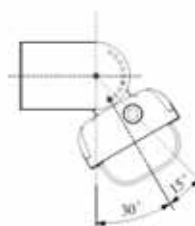

支架式安装 Bracket type

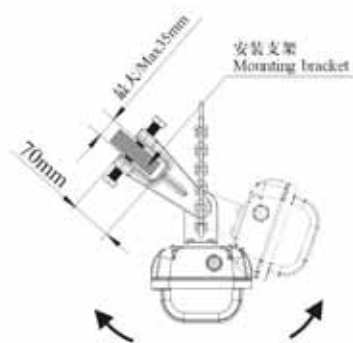

角度可调
The angle is adjustable

- 安装形式和外形尺寸 Mounting ways and outline dimensions:

